

GVS



*Protecting you for
life's best moments.*

European & United Kingdom Product List

Positive pressure loose-fitting respiratory protection



Sikura[®]
— in buone mani

Distributore Autorizzato

**We are the respiratory protection specialists,
dedicated to protecting people for life's best moments.**

Protecting people drives everything we do at GVS-RPB®. For over four decades, we have serviced the industrial market, working with world leading engineers, constantly pushing creative boundaries with new technology that advances our functional capabilities, seeking input from our end users, and refining our range to create the world's best respirators.

As our passion for protecting people continues to grow, we have extended our product range and branched into new industries, sharing our respiratory protection expertise to better the lives of more people. Through this growth, we have taken the next step in our journey, becoming part of the GVS Group, a global manufacturer of filtration devices for the Medical & Life Science, Energy & Mobility, and Health & Safety industries. By teaming up with dedicated filtration specialists, this enables us to expand the possibilities of what personal protection has to offer as we continue to shape the future of respiratory protection.



Powered Air Supply

8 PX5® PAPR

Loose-fitting Respirators

14 Z-Link®

22 Z4®

28 T-Link®

32 T200™

36 Nova 3®

42 Astro™

Supplied Air Supply, Filtration & Monitoring

48 Supplied Air
Flow Control Devices

52 Radex® Airline Filter

56 GX4® Gas Monitor



Powered Air Supply

Sikura
in buone mani

Distributore Autorizzato

GVS | **rpb**

Protecting you for life's best moments.

Our powered air range enables you to move freely around your application while receiving the highest level of respiratory protection when working in hazardous environments. Through positive pressure breathing, our PAPRs support your breathing, helping to reduce the effects of fatigue, so you can perform at your best, for longer.





The PX5® is a portable, battery powered air purifying respirator (PAPR) which draws in contaminated air from the user's immediate vicinity, passing it through internal filters, and supplying the filtered air to an approved loose-fitting respirator headtop.



PX5 PAPR Approved Headtops



Z-Link*
Page 15/16



Z4*
Page 23







T-Link*
Page 29



T200*
Page 33

PX5 PAPR Assemblies

Part #	Description	Certifications
CORE RANGE 03-801-EUUK 	PX5 PAPR Easy Clean Starter Pack Package also includes: ■ Rechargeable battery and charging bank ■ Easy clean belt ■ Flow tester ■ 1x HEPA (P3) filter ■ 1x pre-filters (10pk).	EN12941 IP65
CORE RANGE 03-801-FR-EUUK 	PX5 PAPR Industrial Starter Pack Package also includes: ■ Rechargeable battery and charging bank ■ FR belt ■ Flow tester ■ 1x HEPA (P3) filter ■ 1x spark arrestor ■ 1x pre-filters (10pk).	EN12941 IP65
CORE RANGE 03-802-FR-EUUK 	PX5 PAPR Starter Pack for Gas Filters Package also includes: ■ Rechargeable battery and charging bank ■ FR belt ■ Gas filter door ■ Flow tester ■ 1x spark arrestor ■ 1x pre-filters (10pk). <i>Gas filter sold separately - page 10.</i>	EN12941 IP65
03-803-FR-EUUK 	PX5 PAPR Industrial Starter Pack with Back Harnesses Package also includes: ■ Rechargeable battery and charging bank ■ FR belt with backpack assembly ■ Flow tester ■ 1x HEPA (P3) filter ■ 1x spark arrestor ■ 1x pre-filters (10pk).	EN12941 IP65
03-804-FR-EUUK 	PX5 PAPR Starter Pack for Gas Filters with Back Harnesses Package also includes: ■ Rechargeable battery and charging bank ■ FR belt with backpack assembly ■ Gas filter door ■ Flow tester ■ 1x spark arrestor ■ 1x pre-filters (10pk). <i>Gas filter sold separately - page 10.</i>	EN12941 IP65

PX5 PAPR Filters

Part #	Description	Certifications
CORE RANGE 03-890	Pre-filters (pk 10)	
CORE RANGE 03-891	PAPR Spark Arrestor	
CORE RANGE 03-892-P	HEPA Filter	EN12941
CORE RANGE 03-893-A2	A2P3 Filter	EN12941
03-894-ABE	ABE-P Filter	EN12941
CORE RANGE 03-895-ABEK	ABEK-P Filter	EN12941

PX5 PAPR Accessories

Part #	Description	Certifications
CORE RANGE 03-822-DC	Backpack Assembly - Decon/easy clean.	
CORE RANGE 03-822-FR	Backpack Assembly - FR.	
03-841	Tychem® 4000 PAPR Multi-Gas Cover (pk 10)	
03-842	Zytec® FR PAPR Multi-Gas Cover (pk 10)	
CORE RANGE 04-852	Tychem® Breathing Tube Cover <i>- breathing tube not included.</i>	
CORE RANGE 04-854	FR Breathing Tube Cover <i>- breathing tube not included.</i>	
CORE RANGE 04-855	Aluminized Breathing Tube Cover <i>- breathing tube not included.</i>	
04-856	Disposable/Decon Breathing Tube Sleeve (pk 10) <i>- breathing tube not included.</i>	
04-872	Short Tychem® Breathing Tube Cover <i>- for backpack assembly, breathing tube not included.</i>	
CORE RANGE 04-874	Short FR Breathing Tube Cover <i>- for backpack assembly, breathing tube not included.</i>	
04-875	Short Aluminized Breathing Tube Cover <i>- for backpack assembly, breathing tube not included.</i>	

PX5 PAPR Parts

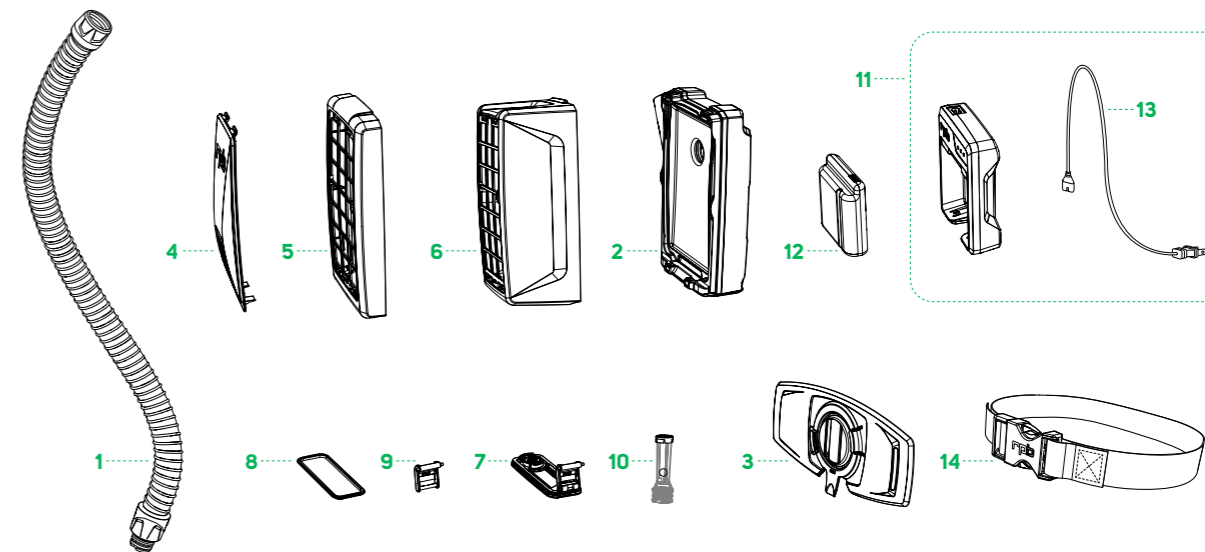

Part # / Description	Part # / Description
CORE RANGE 1 04-831 PAPR Breathing Tube	8 03-817 Battery Door Seal
CORE RANGE - 04-841 Short PAPR Breathing Tube <i>- for backpack assembly.</i>	9 03-818 Door Hinge
- 04-843 PAPR Coupler Seal (pk 5)	10 03-819 Flow Meter
2 03-810 Fan Housing	CORE RANGE 11 03-851-EU/UK Battery Charger - EU/UK.
3 03-811 Belt Support Mount	CORE RANGE 12 03-855 Battery
4 03-812 Door Cover	CORE RANGE 12 03-856 High Capacity Battery
5 03-813 HEPA (P3) Filter Door	13 09-021-EU RPB® Power Cable - EU plug.
6 03-814 Gas Filter Door	13 09-021-UK RPB® Power Cable - UK plug.
7 03-815 Battery Door Assembly <i>- includes 03-818.</i>	14 07-765-DC RPB® 2 Inch Belt Assembly <i>- Easy clean.</i>
	14 07-765-FR RPB® 2 Inch Belt Assembly <i>- FR.</i>

Loose-fitting Respirators

Sikura
in buone mani

Distributore Autorizzato

GVS | **rpb**

Protecting you for life's best moments.

Our range of loose-fitting respirators pair with our supplied and powered air systems to provide you with positive pressure breathing, protecting you in the most hazardous of environments.





The Z-Link® is a versatile powered or supplied air loose-fitting respirator that provides respiratory protection for a range of applications. Depending on assembly configuration, the Z-Link provides certified eye, face, head, and hearing protection.



Z-Link Headtops for Powered Air (PX5® PAPR)

Part #	Description	Certifications
CORE RANGE 16-010-31-CE	 Z-Link Respirator - Zytec® FR Chin Seal Package also includes: ■ Safety lens ■ PX5 breathing tube.	EN12941 TH2, EN166 1BT 9 3, EN397
CORE RANGE 16-010-12-CE	 Z-Link Respirator - Tychem® 2000 Face Seal Package also includes: ■ Safety lens ■ PX5 breathing tube.	EN12941 TH2, EN166 1BT 9 3, EN397
CORE RANGE 16-010-11-CE	 Z-Link Respirator - FR Face Seal Package also includes: ■ Safety lens ■ PX5 breathing tube.	EN12941 TH2, EN166 1BT 9 3, EN397
CORE RANGE 16-010-21-CE	 Z-Link Respirator - FR Shoulder Cape Package also includes: ■ Safety lens ■ PX5 breathing tube.	EN12941 TH3, EN166 1BT 9 3, EN397
CORE RANGE 16-010-24-CE	 Z-Link Radiant Heat Respirator Package also includes: ■ Safety lens ■ Aluminized shoulder cape, top, rear and breathing tube cover ■ PX5 breathing tube. <i>- gold lens sold separately - page 17.</i>	EN12941 TH3, EN166 1BT 9 3, EN397

Z-Link Headtops for Supplied (Compressed) Air

Part #	Description	Certifications
16-020-12	 Z-Link Respirator - Tychem® 2000 Face Seal Package also includes: ■ Safety lens ■ Low flow indicator ■ SAR breathing tube. <i>- flow device sold separately - page 49.</i>	EN14594, EN166 1BT 9 3, EN397
16-020-11	 Z-Link SAR Respirator - FR Face Seal Package also includes: ■ Safety lens ■ Low flow indicator ■ SAR breathing tube. <i>- flow device sold separately - page 49.</i>	EN14594, EN166 1BT 9 3, EN397
16-020-21	 Z-Link Respirator - FR Shoulder Cape Package also includes: ■ Safety lens ■ Low flow indicator ■ SAR breathing tube. <i>- flow device sold separately - page 49.</i>	EN14594, EN166 1BT 9 3, EN397



















Z-Link Headtops for Powered Air (PX5® PAPR)

Part #	Description	Certifications
16-000-11-CE	 Z-Link Respirator - Zytect® FR Face Seal Package also includes: ■ Safety lens.	EN12941 TH3, EN166 1BT 9 3, EN397
16-000-12-CE	 Z-Link Respirator - Tychem® 2000 Face Seal Package also includes: ■ Safety lens.	EN12941 TH3, EN166 1BT 9 3, EN397
16-000-21-CE	 Z-Link Respirator - FR Shoulder Cape Package also includes: ■ Safety lens.	EN12941 TH3, EN166 1BT 9 3, EN397
16-000-23-CE	 Z-Link Respirator - Tychem® 4000 Shoulder Cape Package also includes: ■ Safety lens.	EN12941 TH3, EN166 1BT 9 3, EN397
16-000-24-CE	 Z-Link Radiant Heat Respirator Package also includes: ■ Safety lens ■ Aluminized shoulder cape, top, rear and breathing tube cover ■ PX5 breathing tube. - gold lens sold separately - page 17.	EN12941 TH3, EN166 1BT 9 3, EN397
16-000-31-CE	 Z-Link Respirator - Zytect® FR Chin Seal Package also includes: ■ Safety lens.	EN12941 TH2, EN166 1BT 9 3, EN397







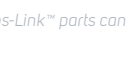













Z-Link Headtops with Powered Air (PX5® PAPR)

Part #	Description	Certifications
CORE RANGE 16-0109	 Z-Link Respirator - Zytect® FR Chin Seal with PX5® PAPR Package also includes: ■ Safety lens ■ PX5® PAPR FR assembly	EN12941 TH2, EN166 1BT 9 3, EN397













Z-Link Accessories

Part #	Description	Certifications
CORE RANGE 04-852	 Tychem® Breathing Tube Cover - breathing tube not included.	
CORE RANGE 04-854	 FR Breathing Tube Cover - breathing tube not included.	
CORE RANGE 04-855	 Aluminized Breathing Tube Cover - breathing tube not included.	
04-856	 Disposable/Decon Breathing Tube Sleeve (pk 10) - breathing tube not included.	
04-872	 Short Tychem® Breathing Tube Cover - for backpack assembly, breathing tube not included.	
CORE RANGE 04-874	 Short FR Breathing Tube Cover - for backpack assembly, breathing tube not included.	
04-875	 Short Aluminized Breathing Tube Cover - for backpack assembly, breathing tube not included.	
16-512	 Heat Resistant Velcro Fastener Kit	
16-520-S	 Comfort-Fit Side Padding System	
CORE RANGE 16-670	 Z-Link+® Weld Visor - includes 1/1/1/2 ADF Lens.	EN379 EN175
16-724	 Aluminized Shoulder Cape	
16-744	 Aluminized Top Cover	
16-754	 Aluminized Rear Cover	
CORE RANGE 16-675-GT	 Radiant Heat Gold Visor - Clear - includes Cover Clip and Retainer Assembly.	
CORE RANGE 16-675-GTIR5	 Radiant Heat Gold Visor - IR5 - includes Cover Clip and Retainer Assembly.	
16-675-IR5	 Radiant Heat IR5 Visor - includes Cover Clip and Retainer Assembly.	
16-901	 Vision-Link® Helmet Light Kit* - includes 09-510-RAW, 16-918 and 15-839.	
16-922	 Comms-Link® In-Helmet Communication System* (Non IS) - includes 16-529 and 09-913. Radio adaptor sold separately - contact RPB for more information.	
18-533	 Quiet-Link® Helmet Mounted Earmuffs - includes 18-535 suspension bracket.	EN352-3
18-535	 Quiet-Link® Suspension Brackets	

Z-Link Consumables

Part #	Description	Certifications
CORE RANGE 04-831	 PAPR Breathing Tube	
CORE RANGE 04-833	 SAR Breathing Tube	
CORE RANGE 04-841	 Short Breathing Tube <i>- for backpack assembly.</i>	
CORE RANGE 16-526	 Head Band Brow Pad	
CORE RANGE 16-675-GT	 Radiant Heat Gold Visor - Clear - Replacement <i>- includes Cover Clip and Retainer Assembly.</i>	
CORE RANGE 16-675-GTIR5	 Radiant Heat Gold Visor - IR5 - Replacement <i>- includes Cover Clip and Retainer Assembly.</i>	
CORE RANGE 16-675-IR5	 IR5 Visor - Replacement <i>- includes Cover Clip and Retainer Assembly.</i>	
CORE RANGE 16-810	 Safety Lens - Clear - Single <i>- anti-fog/anti scratch.</i>	EN166
CORE RANGE 16-810-IR5	 Safety Lens - IR Tint, Shade 5 <i>- anti scratch.</i>	EN166
CORE RANGE 16-810-MT	 Safety Lens - Mirror Tint <i>- anti-fog/anti scratch.</i>	EN166
CORE RANGE 16-810-ST	 Safety Lens - Smoke Tint <i>- anti-fog/anti scratch.</i>	EN166
CORE RANGE 16-810-YT	 Safety Lens - Yellow Tint <i>- anti-fog/anti scratch.</i>	EN166
CORE RANGE 16-811	 Tear-Off Lens (pk 50)	
CORE RANGE 16-872	 Welding ADF/Fixed Shade Impact Lens (pk 10)	
CORE RANGE 16-872-AL	 Welding ADF Impact Lens - Aluminium Coated <i>- radiant heat.</i>	
CORE RANGE 16-873	 Welding ADF Rear Lens (pk 10)	
CORE RANGE 16-874	 Protective Lens for Aluminium Coated Impact Lens (10pk)	
CORE RANGE 16-877	 110x90 Fixed Shade Welding Lens Adaptor Frame	
CORE RANGE 16-877-(5, 8, 9, 10, 11 or 12)	 Fixed Shade Welding Lens <i>- available in 5, 8, 9, 10, 11 and 12.</i>	
CORE RANGE 16-878	 Welding Fixed Shade Rear Lens (pk 10)	

Vision-Link® Parts Available for Z-Link®, T-Link® and Z4®

Part #	Description	Certifications
09-050	 Two Bay Battery Charger	
09-055	 Lithium Ion Battery	
15-839	 Jaw Mount - for Z-Link, Z4 <i>- screw not included.</i>	
CORE RANGE 16-910	 LED Light Body Assembly <i>- battery and charger not included.</i>	
16-913	 Rear Cowling	
16-915	 Cowling Seal	
16-916	 Protective Lens	
16-917	 Latch	
16-918	 Jaw Mount - for T-Link <i>- includes screw.</i>	
16-919	 QR Latch Lever	
16-923	 Hinge Pin	
16-926	 Latch Lever Assembly <i>- includes 16-919.</i>	

Comms-Link® Parts Available for Z-Link®, T-Link® and Z4®

Part #	Description	Certifications
09-913	 Push to Talk Button	
09-930	 Motorola Connection Cable - two-pin.	
09-931	 Motorola Connection Cable - multi-pin.	
09-932	 Motorola Connection Cable - multi-pin.	
09-933	 Kenwood Connection Cable - two-pin.	
09-934	 Motorola Connection Cable - multi-pin.	
09-935	 Motorola Connection Cable - single-pin.	
16-529	 Communication Retainer Clip	

Z-Link Parts

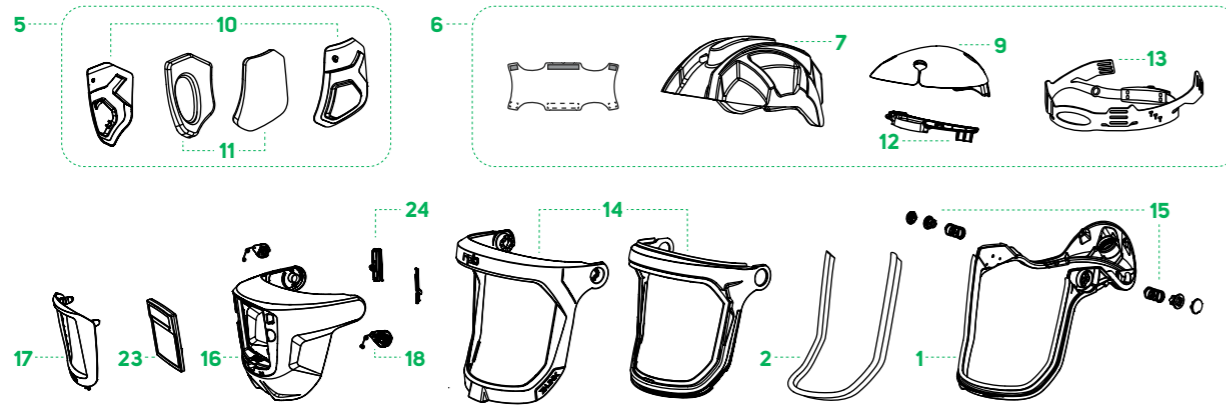

Part # / Description	Part # / Description
1  16-514 Jaw Assembly - includes screws and 16-515.	13  16-531 Head Harness Assembly - includes 16-530.
2  16-515 Lens Seal - for jaw assembly.	14  16-611 Visor
-  16-516 Quiet-Link™ Earmuff Bracket - pair, includes screws.	15  16-616 Pivot Assembly
-  16-516-1 Quiet-Link™ Earmuff Bracket with Cape Retainer - pair, includes screws.	16  16-671 Z-Link+™ Weld Visor - ADF lens not included.
-  16-518 Rear Cape Clip	17  16-672 Welding Lens Retainer
-  16-519 Air Inlet Adapter	18  16-673 Z-Link+™ Weld Visor Attachment Clips and Springs
5  16-520-S Comfort-Fit Side Padding System	19  16-711 Zytec® FR Face Seal
6  16-520-T Fit System	19  16-712 Tychem® 2000 Face Seal
7  16-521 Impact Absorber	-  16-721 Zytec® FR Shoulder Cape
8  16-522 Comfort Pad	-  16-723 Tychem® 4000 Shoulder Cape
-  16-523 Air Director	-  16-724 Aluminized Shoulder Cape
9  16-525 Head Harness Bracket and Air Director	-  16-731 Zytec® FR Chin Seal
10  16-527 Comfort-Fit Side Padding Frames	23  16-871 RPB® Auto Darkening Filter (ADF) - 1/1/1/2, EN379, EN175.
11  16-528 Comfort-Fit Foam Pads - pair.	24  16-875 Magnifying Lens Holder Assembly
12  16-530 Head Harness Ratchet Assembly	-  16-876 Clip for Weld Lens
	-  16-930 Low Flow Indicator





The Z4[®] is a loose-fitting welding/grinding respirator that provides the user with certified breathing, eye and hearing protection while performing heavy industry welding related applications.













Z4 Headtop

Part #	Description	Certifications
CORE RANGE		
15-018-11-EUUK	Z4 Respirator Weld/Grind Starter Pack Package also includes: <ul style="list-style-type: none"> ■ 1/1/1/2 ADF lens ■ FR face seal ■ Quiet-Slim™ earmuffs ■ PX5[®] Breathing tube ■ PX5[®] PAPR ■ Rechargeable battery and charging bank ■ FR belt ■ 1 x HEPA (P3) filter ■ 1 x spark arrestor ■ 1 x pre-filters (10pk). - additional filters available as required - page 10.	EN12941 TH2 EN166 1B EN379 EN175 EN352-1 EN812 optional











Z4 Headtop Packages

Part #	Description	Certifications
CORE RANGE		
15-010-11-CE	Z4 Respirator - FR Face Seal Package also includes: <ul style="list-style-type: none"> ■ 1/1/1/2 ADF lens ■ Quiet-Slim™ earmuffs ■ PX5[®] breathing tube. - PAPR sold separately - page 9.	EN12941 TH2 EN166 1B EN379 EN175 EN352-1 EN812 optional
15-010-21-CE	Z4 Respirator - FR Shoulder Cape Package also includes: <ul style="list-style-type: none"> ■ 1/1/1/2 ADF lens ■ Quiet-Slim™ earmuffs ■ PX5[®] breathing tube. - PAPR sold separately - page 9.	EN12941 TH2 EN166 1B EN379 EN175 EN352-1 EN812 optional
15-000-21-CE	Z4 Respirator - FR Shoulder Cape ■ Quiet-Slim™ earmuffs. - ADF lens and breathing tube not included. PAPR sold separately - page 9.	EN12941 TH2 EN166 1B EN352-1 EN812 optional
15-100-11-CE	Z4 Respirator - FR Face Seal Package also includes: <ul style="list-style-type: none"> ■ 1/1/1/2 ADF lens ■ Quiet-Slim™ earmuffs. - PAPR sold separately - page 9.	EN12941 TH2 EN166 1B EN379 EN175 EN352-1 EN812 optional
15-100-21-CE	Z4 Respirator - FR Shoulder cape Package also includes: <ul style="list-style-type: none"> ■ 1/1/1/2 ADF lens ■ Quiet-Slim™ earmuffs. - PAPR sold separately - page 9.	EN12941 TH2 EN166 1B EN379 EN175 EN352-1 EN812 optional

Z4 Accessories









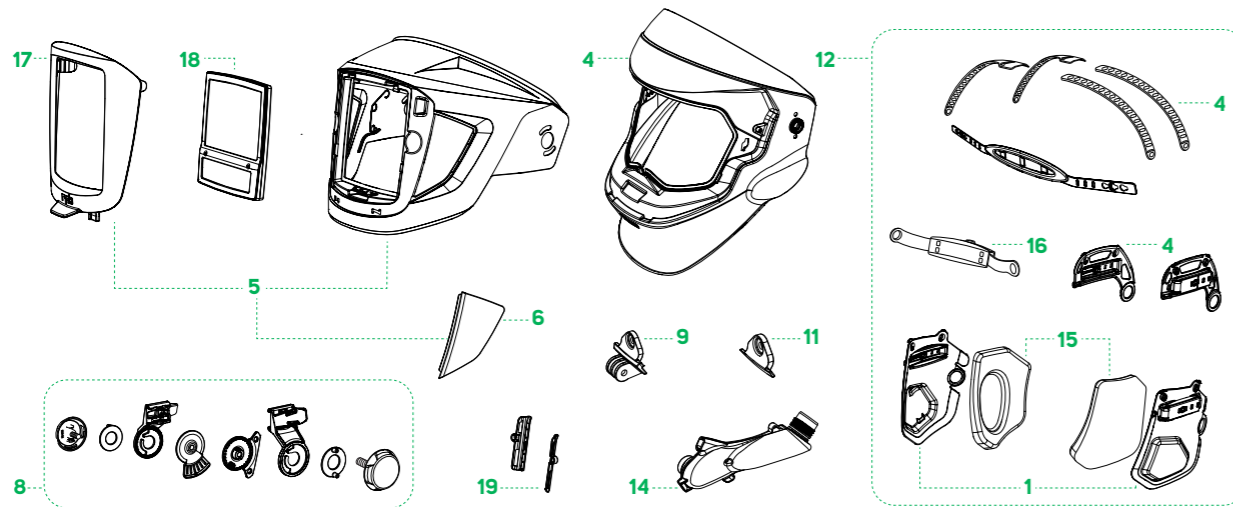

Part #	Description	Certifications
CORE RANGE 04-854	 FR Breathing Tube Cover <i>- breathing tube not included.</i>	
CORE RANGE 04-874	 Short FR Breathing Tube Cover <i>- for backpack assembly, breathing tube not included.</i>	
15-821-5	 Side Window Blockers - Shade 5 <i>- pair.</i>	
15-848	 Comfort-Fit Side Padding System <i>- includes Velcro™ pieces.</i>	
15-850	 Bump Cap <i>- includes Comfort and Brow Pad and Front Strap.</i>	
15-855	 Bump Cap <i>- includes Comfort Pad.</i>	
16-901	 Vision-Link™ Helmet Light Kit* <i>- includes 09-510-RAW, 16-918 and 15-839.</i>	
16-922	 Comms-Link™ In-Helmet Communication System* <i>(Non IS) - includes 16-529 and 09-913. Radio adaptor sold separately - contact RPB for more information.</i>	
18-524	 Quiet-Slim™ Earmuffs	EN352-1
18-600	 RPB® Carry Bag	

Z4 Consumables

Part #	Description	Certifications
CORE RANGE 04-831	 PAPR Breathing Tube	
CORE RANGE 04-833	 Breathing Tube	
CORE RANGE 04-841	 Short Breathing Tube <i>- for Backpack Assembly.</i>	
13-072-(1, 1.5, 2 or 2.5)	 Ultra Magnifying Lens <i>- available in 1.0, 1.5, 2.0 and 2.5.</i>	
CORE RANGE 15-878	 Safety Lens (pk 10)	EN166
CORE RANGE 16-526	 Head Band Brow Pad	
CORE RANGE 16-872	 Welding ADF/Fixed Shade Impact Lens (pk 10)	
CORE RANGE 16-873	 Welding ADF Rear Lens (pk 10)	
16-874	 Protective Lens for ADF Impact Lens - Aluminium Coated (pk 10)	
CORE RANGE 16-878	 Welding Fixed Shade Rear Lens (pk 10)	

Z4 Parts



Part # / Description	Part # / Description
1  15-148 Side Pad Mounts - pair, includes Velcro™ pieces.	-  15-832 Safety Lens Bayonet - pair.
-  15-711 FR Face Seal	11  15-839 Vision-Link™ Jaw Mount - screw not included.
-  15-721 FR Shoulder Cape	12  15-840 Head Harness Assembly - includes 16-530 and 15-848.
4  15-811 Face Shield	-  15-842 Harness Mount - pair.
5  15-812 Weld Visor Assembly - includes 16-672 and 15-821.	14  15-851-1 Air Intake Assembly - includes screws.
6  15-821 Side Window Blockers - pair, solid grey.	15  16-528 Foam Side Pads - pair.
-  15-822 Spring Assembly Kit	16  16-530 Head Harness Ratchet Assembly
8  15-830 Head Harness Bracket and Adjustment System	17  16-672 Welding Lens Retainer
9  15-831 Front Cape Clip Cover	18  16-871 RPB® Auto Darkening Filter (ADF) - 1/1/1/2, EN379, EN175.
	19  16-875 Magnifying Lens Holder Assembly





The T-Link® is a versatile powered or supplied air loose-fitting respirator that provides respiratory protection for a range of industrial applications. Depending on assembly configuration, the T-Link provides certified eye, face, head, and hearing protection.



T-Link Headtops for Powered Air (PX5® PAPR)

Part #	Description	Certifications
CORE RANGE		
17-110-12-CE	 T-Link Respirator, Bump Cap - Tychem® 2000 Hood <i>Package also includes:</i> ■ PX5 breathing tube.	EN12941 3B EN812 EN166
17-000-12-CE	 T-Link Respirator, Hard Hat - Tychem® 2000 Hood	EN12941 3B EN166
17-100-12-CE	 T-Link Respirator, Bump Cap - Tychem® 2000 Hood	EN12941 3B EN812 EN166

T-Link Headtops for Supplied (Compressed) Air

Part #	Description	Certifications
CORE RANGE		
17-120-12	 T-Link SAR Respirator, Bump Cap - Tychem® 2000 Hood <i>Package also includes:</i> ■ Low flow indicator ■ SAR breathing tube. - flow device sold separately - page 49.	EN14594 3B EN812 EN166
17-020-12	 T-Link SAR Respirator, Hard Hat - Tychem® 2000 Hood <i>Package also includes:</i> ■ Low flow indicator ■ SAR breathing tube. - flow device sold separately - page 49.	EN14594 B3 EN397 EN166

T-Link Accessories

Part #	Description	Certifications
CORE RANGE		
04-852	Tychem® Breathing Tube Cover - breathing tube not included.	
04-856	Disposable/Decon Breathing Tube Sleeve (pk 10) - breathing tube not included.	
04-872	Short Tychem® Breathing Tube Cover - for backpack assembly, breathing tube not included.	
16-520-S	Comfort-Fit Side Padding System	
16-901	Vision-Link® Helmet Light Kit* - includes 09-510-RAW, 16-918 and 15-839.	
16-922	Comms-Link® In-Helmet Communication System* (Non IS) - includes 16-529 and 09-913. Radio adaptor sold separately - contact RPB for more information.	
18-533	Quiet-Link™ Helmet Mounted Earmuffs - includes 18-535 suspension bracket.	EN352-3
18-535	Quiet-Link™ Suspension Brackets	
18-600	RPB® Carry Bag	

T-Link Consumables

Part #	Description	Certifications
CORE RANGE		
04-831	PAPR Breathing Tube	
CORE RANGE		
04-841	Short Breathing Tube - for Backpack Assembly.	
CORE RANGE		
16-526	Head Band Brow Pad	
17-712	Tychem® 2000 Hood - replacement hood.	
17-713	Tychem® 4000 Hood with Sealed Seams - replacement hood.	
17-713-SX	Tychem® 4000 Extra Length Hood with Sealed Seams, Safety Lens and Waist Straps - replacement hood.	EN166 1F 3
CORE RANGE		
17-815	Peel-off Lens (pk 25)	
17-817	Clear Vision Cassette Lens (pk 10) - 7 layers.	

T-Link Parts

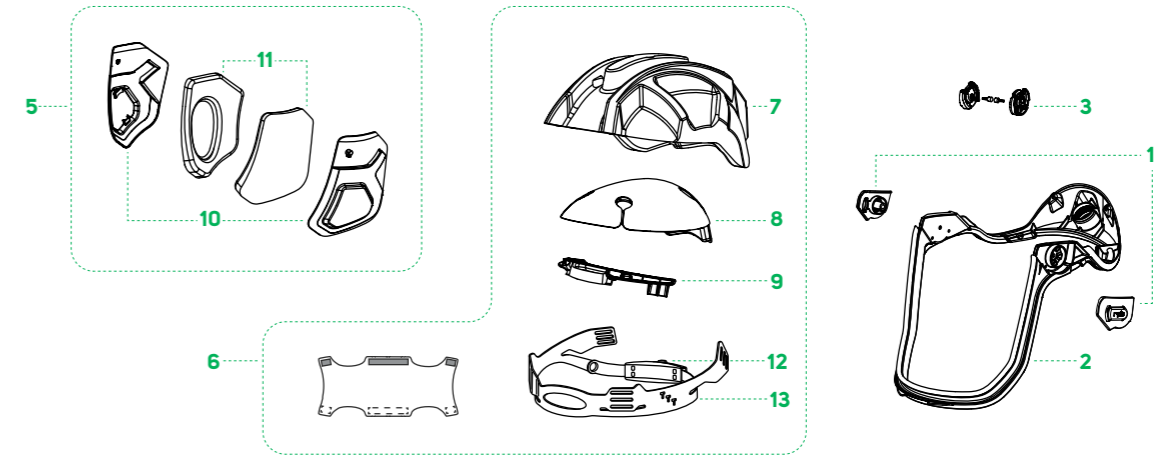









Part # / Description	Part # / Description
1 17-512 Lens Mount Clips - pair.	8 16-522 Comfort Pad
2 16-514 Jaw Assembly - includes screws and 16-515.	9 16-525 Head Harness Bracket and Air Director
3 16-516 Quiet-Link™ Earmuff Bracket - pair, includes screws.	10 16-527 Comfort-Fit Side Padding Frames
- 16-519 Air Inlet Adapter	11 16-528 Comfort Fit Foam Pads - pair.
5 16-520-S Comfort-Fit Side Padding System	12 16-530 Head Harness Ratchet Assembly
6 16-520-T Fit System	13 16-531 Head Harness Assembly - includes 16-530.
7 16-521 Impact Absorber	- 16-930 Low Flow Indicator
	- 17-110 Bump Cap Assembly



The T200™ is a lightweight respirator designed for healthcare and life science applications. When used with powered air, the T200 provides respiratory, eye, and face protection.



T200 Headtops for Powered Air (PX5® PAPR)

Part #	Description	Certifications
CORE RANGE 17-200-22-CE	 T200 Respirator, Head Harness - Tychem® 2000 Face Seal <i>Package also includes:</i> <ul style="list-style-type: none"> Head harness assembly PX5 breathing tube. 	EN12941 TH3 EN166 1F 3
CORE RANGE 17-200-32-CE	 T200 Respirator, Head Harness - Tychem® 2000 Hood with Face Seal <i>Package also includes:</i> <ul style="list-style-type: none"> Head harness assembly PX5 breathing tube. 	EN12941 TH3 EN166 1F 3
17-202-22-CE	 T200 Respirator, Head Harness - Tychem® 2000 Face Seal <i>Package also includes:</i> <ul style="list-style-type: none"> Head harness assembly. 	EN12941 TH3 EN166 1F 3
17-202-32-CE	 T200 Respirator, Head Harness - Tychem® 2000 Hood with Face Seal <i>Package also includes:</i> <ul style="list-style-type: none"> Head harness assembly. 	EN12941 TH3 EN166 1F 3
CORE RANGE 17-210-22-CE	 T200 Respirator, Bump Cap - Tychem® 2000 Face Seal <i>Package also includes:</i> <ul style="list-style-type: none"> Bump Cap assembly PX5 breathing tube. 	EN12941 TH3 EN166 1F 3 EN812
17-210-32-CE	 T200 Respirator, Bump Cap - Tychem® 2000 Hood with Face Seal <i>Package also includes:</i> <ul style="list-style-type: none"> Bump Cap assembly PX5 breathing tube. 	EN12941 TH3 EN166 1F 3 EN812
17-212-22-CE	 T200 Respirator, Bump Cap - Tychem® 2000 Face Seal <i>Package also includes:</i> <ul style="list-style-type: none"> Bump cap assembly. 	EN12941 TH3 EN166 1F 3 EN812
17-212-32-CE	 T200 Respirator, Bump Cap - Tychem® 2000 Hood with Face Seal <i>Package also includes:</i> <ul style="list-style-type: none"> Bump cap assembly. 	EN12941 TH3 EN166 1F 3 EN812

T200 Headtops with Powered Air (PX5® PAPR)

Part #	Description	Certifications
CORE RANGE 17-0106	 T200 Respirator, Bump Cap - Tychem® 2000 Face Seal with PX5® PAPR <i>Package also includes:</i> <ul style="list-style-type: none"> Head harness assembly Bump Cap PX5 PAPR assembly. 	EN12941 TH3 EN166 1F 3 EN812

T200 Accessories

Part #	Description	Certifications
CORE RANGE 04-852	Tychem® Breathing Tube Cover - breathing tube not included.	
04-856	Disposable/Decon Breathing Tube Sleeve (pk 10) - breathing tube not included.	
04-872	Short Tychem® Breathing Tube Cover - for backpack assembly, breathing tube not included.	
15-850	Bump Cap - includes Comfort and Brow Pad and Front Strap.	
15-855	Bump Cap - includes Comfort Pad.	
18-524	Slim-Line Ear Defenders	EN352-1
18-600	RPB® Carry Bag	

T200 Consumables

Part #	Description	Certifications
CORE RANGE 04-831	PAPR Breathing Tube	
CORE RANGE 04-833	Breathing Tube	
CORE RANGE 04-841	Short Breathing Tube - for Backpack Assembly.	
CORE RANGE 16-526	Head Band Brow Pad	
17-712	Tychem® 2000 Hood with Neck Seal - replacement hood.	
17-713	Tychem® 4000 Hood with Sealed Seams - replacement hood.	
CORE RANGE 17-722	Tychem® 2000 Face Seal - replacement hood.	EN166 1F 3
CORE RANGE 17-732	Tychem® 2000 Hood with Face Seal - replacement hood.	EN166 1F 3
17-811	Clear Vision Cassette Lens (pk 10) - 7 layers, for face seal hoods.	
CORE RANGE 17-815	Tear-off Lens (pk 25) - for full length hoods.	
17-817	Clear Vision Cassette Lens (pk 10) - 7 layers.	

T200 Parts

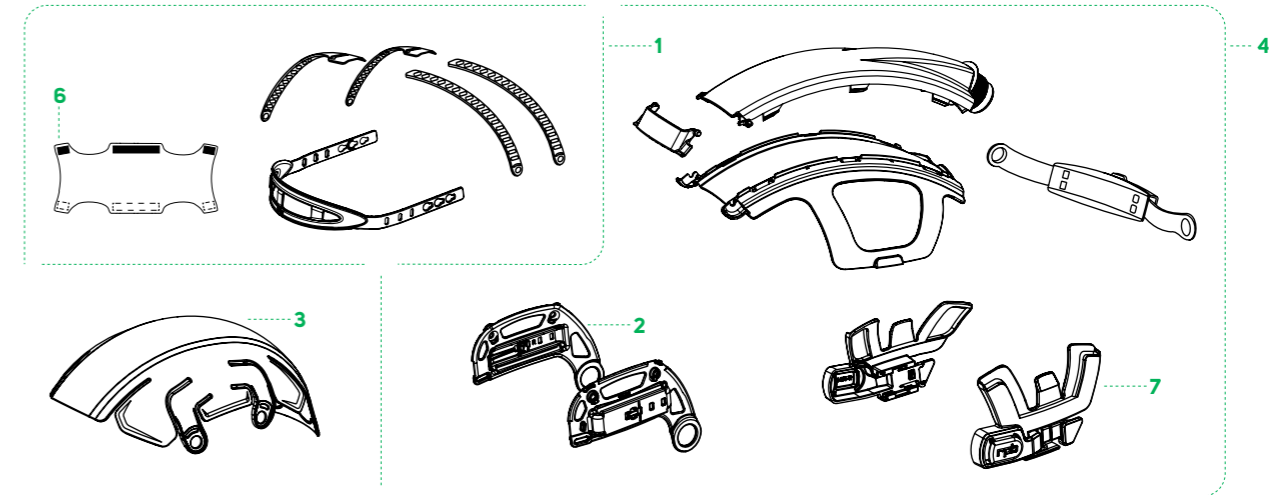

Part # / Description	Part # / Description
1 15-841 Head Harness Assembly	4 15-870 Head Harness Assembly with Air Duct and Lens Mount Clips
2 15-842 Harness Mount - pair.	5 16-530 Head Harness Ratchet Assembly
3 15-850 Bump Cap - includes Comfort and Brow Pad and Front Strap.	CORE RANGE 6 16-526 Head Band Brow Pad
- 15-855 Bump Cap - includes Comfort Pad.	7 17-513 Lens Mounts - pair.









The Nova 3[®] is a supplied air, loose-fitting, heavy industry respirator. Designed for all forms of abrasive blasting and other industrial applications where there is a need for respiratory, eye, face, head, and hearing protection.









Nova 3 Headtops for Supplied (Compressed) Air

Part #	Description	Certifications
CORE RANGE		
NV3-711-50	 <p>Nova 3 Blast Respirator with Constant Flow Valve Package also includes: ■ Constant flow valve ■ Low flow indicator ■ Nylon cape ■ SAR breathing tube.</p>	EN14594 4B EN166 EN397
CORE RANGE		
NV3-715-50	 <p>Nova 3 Blast Respirator with Climate Control Package also includes: ■ C40[™] Climate Control Device ■ Low flow indicator ■ Nylon cape ■ SAR breathing tube.</p>	EN14594 4B EN14594 EN166 EN397











Nova 3 Accessories

Part #	Description	Certifications
CORE RANGE		
03-502	 <p>C40[™] Climate Control Device - CE</p>	EN14594
07-701	 <p>RPB[®] Leather Gloves</p>	
07-755-S	RPB [®] Heavy Duty Blast Suit - Small	
07-755-M	RPB [®] Heavy Duty Blast Suit - Medium	
07-755-L	RPB [®] Heavy Duty Blast Suit - Large	
07-755-XL	 <p>RPB[®] Heavy Duty Blast Suit - X Large</p>	
07-755-XXL	RPB [®] Heavy Duty Blast Suit - XX Large	
07-755-XXXL	RPB [®] Heavy Duty Blast Suit - XXX Large	
07-755-XXXXL	RPB [®] Heavy Duty Blast Suit - XXXX Large	
07-761	 <p>RPB[®] Knee Pads - pair.</p>	
09-502-G	 <p>L4[™] Blast Light Assembly[*] - Global power connections.</p>	
09-903	 <p>Nova 3[™] Talk[™] In-Helmet Communication Upgrade Kit[*] - radio adaptor sold separately.</p>	









Nova 3 Consumables

Part #	Description	Certifications
CORE RANGE NV2021B	 SAR Breathing Tube	
CORE RANGE NV3-722	 Inner Lens (pk 10)	
NV3-722-T	 Inner Lens - Tinted (pk 10)	
CORE RANGE NV3-724	 Outer Lens (pk 50)	
CORE RANGE NV3-725	 Tear-off Lens (pk 50)	
CORE RANGE NV3-745	 Cassette Lens (pk 20) <i>- each cassette includes 5x tear-offs and 1x outer lens.</i>	
NV3-746	 Mesh Screen (pk 2)	

Nova Talk Parts

Part #	Description	Certifications
09-913	 Push to Talk Button	
09-916	 R-Tex High Noise Headset <i>- includes PTT, radio not supplied.</i>	
09-930	 Motorola Connection Cable - two-pin.	
09-931	 Motorola Connection Cable - multi-pin.	
09-932	 Motorola Connection Cable - multi-pin.	
09-933	 Kenwood Connection Cable - two-pin.	
09-934	 Motorola Connection Cable - multi-pin.	
09-938	 Cable for VX-261	
09-939	 Cable for Apex Icom IC-F4002	
NV3-733TK	 Nova 3 Talk™ Side Padding Covers <i>- 5 pairs.</i>	

L4 Light Parts

Part #	Description	Certifications
07-122	 Cable and Hose Clamp	
09-021-EU	 Power Cable - EU.	
09-021-UK	 Power Cable - UK.	
09-512	 L4™ Light and Mount Kit <i>- includes 09-520.</i>	
09-520	 Mounting Clip	
09-522	 Outer Lens (pk 10)	
09-525	 Battery Charger <i>- Power Cable not included.</i>	
09-532-2	 Battery Pack	

Nova 3 Parts

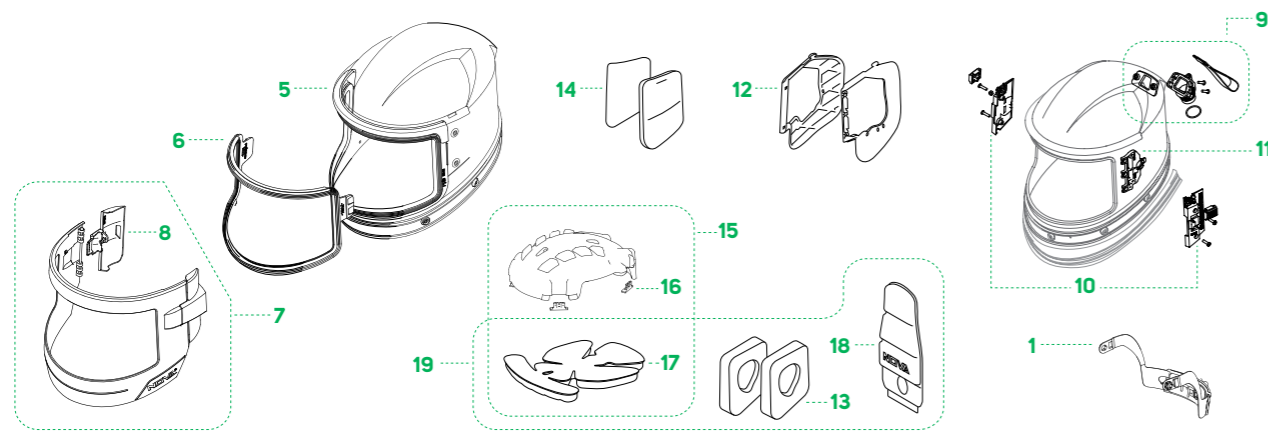

Part # / Description	Part # / Description
1  07-900 Adjustable Head Support	14  NV3-733 Side Padding Covers - 5 pairs.
-  NV2012 Inner Bib	15  NV3-734 Head Liner Kit - includes NV3-734-1.
-  NV2030 Low Flow Indicator Assembly	16  NV3-734-1 Head Liner Clips (pk 4)
-  NV2041 Domes - 8 sets.	17  NV3-735 Head Liner Foam Padding
5  NV3-721 Inner Gasket	18  NV3-735-1 Neck Pad
6  NV3-723 Inner Lens Frame	19  NV3-736- (A05, A10, A15 or A20) Hygiene Kit - available in 5mm, 10mm, 15mm or 20mm.
7  NV3-726 Visor Kit - includes hinge and latch.	-  NV3-750 Nylon Respirator Cape*
-  NV3-727/8 Visor Mount Kit - includes 4pcs FS-40 nuts and 4pcs FS-46 screws.	-  NV3-751 Extra Length Nylon Respirator Cape*
8  NV3-727-2 Hinge Lock	-  NV3-752 Leather Respirator Cape*
9  NV3-729 Air Inlet Kit	-  NV3-753-HD Extra Length, Heavy Duty Leather Respirator Cape*
-  NV3-729-2 Low Flow Indicator Adapter	-  NV3-754 Blast Jacket, Size XL*
11  NV3-730 Padding Connectors - pair.	-  NV3-755 Blast Jacket, Size XXL*
12  NV3-731 Side Padding Frames - pair.	-  NV3-759 Cape Cover Band
13  NV3-732- (A05, A10, A15 or A20) Side Padding Foam & Covers - available in 5mm, 10mm, 15mm or 20mm.	

*Includes NV2012 Inner Bib.





The Astro™ is a high performing economic option for abrasive blasting. Combining multiple items of PPE into one, the Astro provides respiratory, eye, face, head and hearing protection.



Astro Headtop





Part #	Description	Certifications
CORE RANGE		
02-800-CE	 Astro Blast Respirator with Constant Flow Valve <i>Package also includes:</i> <ul style="list-style-type: none"> ■ Constant flow valve ■ Low flow indicator ■ Nylon cape ■ SAR breathing tube. 	EN14594 4B EN166

Astro Consumables

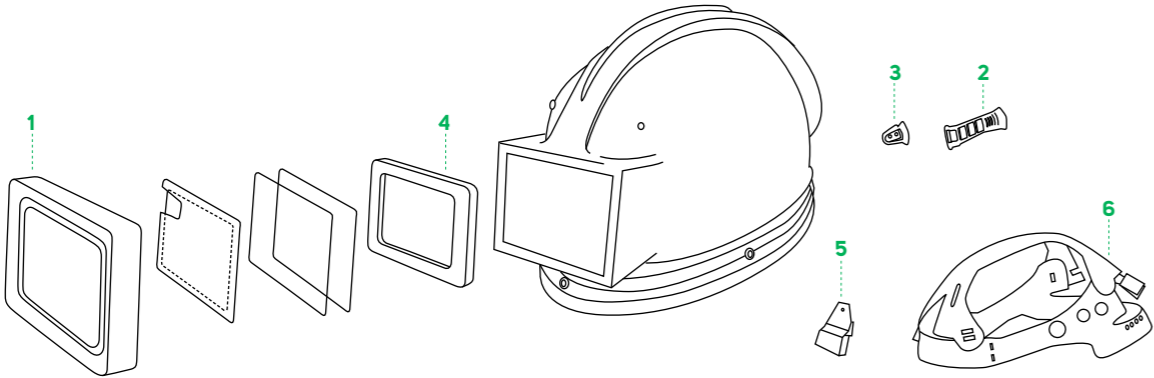
Part #	Description	Certifications
CORE RANGE		
02-810	 Inner Lens (pk 10)	
02-810-T	 Inner Lens - Tinted (pk 10)	
CORE RANGE		
02-811-015	 Outer Lens (pk 50)	
CORE RANGE		
02-816	 Tear-off Lens (pk 50)	
CORE RANGE		
NV2021B	 SAR Breathing Tube	

Astro Parts



Part # / Description	Part # / Description
1  02-804 Visor Kit <i>- includes 02-805 and screws.</i>	02-813 Nylon Respirator Cape
3  02-806 Cleat and Screws	02-814 Leather Respirator Cape
4  02-807 Window Gasket Seal	03-035 Air Inlet Assembly
5  02-808 Head Suspension Clips - <i>pk 4.</i>	NV2012 Inner Bib
6  02-809CE Head Harness	NV2030 Low Flow Indicator Assembly
02-812 Cape Cover Band	NV2041 Domes - <i>8 sets.</i>
	NV2042 Hand Strap



Our supplied air range gives you the confidence that the air you breathe is safe, detecting toxic gases, removing moisture, odor and particulates and controlling the temperature of your supplied air to enhance your safety.





The flow control range allows the operator to control the flow rate, and temperature of their supplied breathing air when paired with their required SAR headtop.

These devices fit around the user's waist (belt included) and connect the supplied breathing airline to the appropriate SAR respirator (sold separately).



Supplied Air Flow Devices

Part #	Description	Certifications
03-102	 Constant Flow Valve Assembly - CE	EN14594
CORE RANGE 03-502	 RPB® C40™ Climate Control Device - CE	EN14594
CORE RANGE 03-502-FR	RPB® C40™ Climate Control Device - FR	EN14594

Supplied Air Breathing Tubes

Part #	Description	Certifications
CORE RANGE 04-833	 Breathing Tube - for Z-Link® and T-Link®.	
CORE RANGE NV2021B	 SAR Breathing Tube - for Nova 3®, Nova 2000® and Astro®.	
CORE RANGE 04-852	 Tychem® Breathing Tube Cover - breathing tube not included.	
CORE RANGE 04-854	 FR Breathing Tube Cover - breathing tube not included.	
CORE RANGE 04-855	 Aluminized Breathing Tube Cover - breathing tube not included.	
04-856	 Disposable/Decon Breathing Tube Sleeve (pk 10) - breathing tube not included.	

Supplied (Compressed) Airline

Part #	Description	Certifications
CORE RANGE 04-322-25	RPB® 7.5M Breathing Airline Hose - CEJN safety couplers.	EN14594
CORE RANGE 04-322-50	RPB® 15M Breathing Airline Hose - CEJN safety couplers.	EN14594
CORE RANGE 04-322-100	RPB® 30M Breathing Airline Hose - CEJN safety couplers.	EN14594

Supplied Air Flow Device Parts

Part #	Description	Certifications
03-022-CF	CEJN Double Action Coupler FNPT	EN14594
03-022-PMS	1/4" Safety Plug to 1/4" NPT Male Swivel	EN14594
4000-12	Temperature Shield	
4000-16	Silencer Disc	
NV2022	1.5" Nylon Belt	
NV2032CE	1/4 Inch Quick Release Plug 1/4 Inch Male Thread	

C40 Climate Control Device Parts

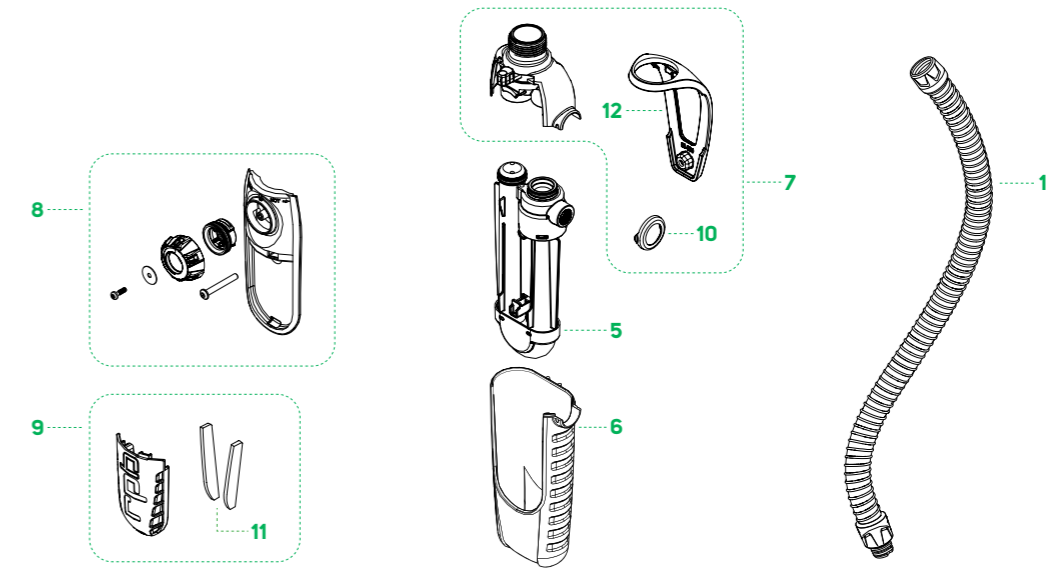



Part # / Description	Part # / Description
CORE RANGE 1 04-833 Breathing Tube - for Z-Link® and T-Link®.	5 03-510 C40™ U Tube Assembly
CORE RANGE - 04-852 Tychem® Breathing Tube Cover - breathing tube not included.	6 03-514 C40™ Bottom Case
CORE RANGE - 04-854 FR Breathing Tube Cover - breathing tube not included.	7 03-521 C40™ Top Case Assembly
CORE RANGE - 04-855 Aluminized Breathing Tube Cover - breathing tube not included.	8 03-522 C40™ Exhaust Assembly
- 04-856 Clear Breathing Tube Cover (pk 10) - breathing tube not included.	9 03-526 C40™ Silencer Assembly
- 04-862 C40™ Tychem® Cover	10 03-536 C40™ Inlet Collar
- 03-022-CF CEJN Double Action Coupler FNPT - NIOSH.	11 03-537 C40™ Silencers - pair.
- 03-022-PMS 1/4" Safety Plug to 1/4" NPT Male Swivel - NIOSH.	12 03-539 C40™ Belt Loop - 03-521 replacement required for pre-July 2020 C40™.
	- 07-765 2" Belt Assembly
	- 07-765-FR 2" Belt Assembly - FR





The Radex® airline filter is a large 6-stage filtration system that removes moisture, odour, and particulates from the compressed air-stream.



Radex Airline Filter Packages









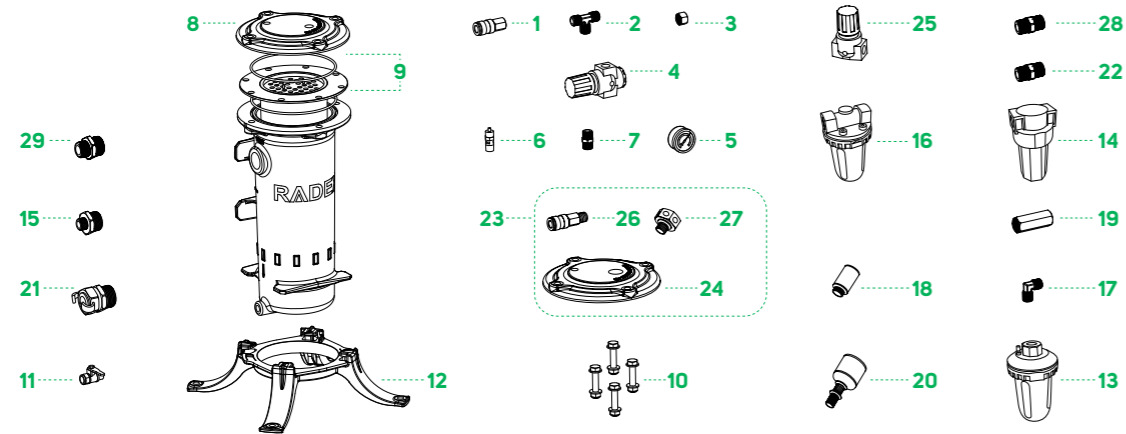















Part #	Description	Certifications
CORE RANGE 04-900 	Radex Airline Filter - 2 Outlet Package also includes: ■ Filter housing ■ Six stage filter cartridge ■ Base/wall mount ■ Pressure regulator and gauge ■ 2x universal couplers.	EN14594
CORE RANGE 04-906 	Radex Airline Filter - 6 Outlet Package also includes: ■ Filter housing ■ Six stage filter cartridge ■ Base/wall mount ■ High flow pressure regulator and gauge ■ 6x universal couplers.	EN14594

Radex Airline Filter Packages

Part #	Description	Certifications
CORE RANGE AFC100 	Replacement Filter Cartridge - generic.	
CORE RANGE APF3100 	Radex 6 Stage Filter Cartridge	

Radex Airline Filter Parts



Part # / Description	Part # / Description
1  04-911 1/4 Inch Coupler 3/8 Inch Female Thread	16  04-927 Mainline Pre-filter
2  04-912 3/8 Inch Brass Tee	17  04-928 Brass Elbow
3  04-913 3/8 Inch Brass Cap	18  04-929 Filter Element - for 04-927.
4  04-914 Pressure Regulator	19  04-930 Micro Mist Filter Element - for 04-925.
5  04-915 Pressure Gauge	20  04-931 Auto Drain Assembly - for 04-924.
6  04-916 Pressure Relief Valve	21  04-951 Claw Coupler
7  04-917 3/8 Inch Brass Nipple	22  04-952 1/2 Inch x 1/2 Inch Male NPT Nipple
8  04-918 Filter Lid	23  04-960 Six Outlet Upgrade Kit
9  04-919 O-Ring - set of 2.	24  04-961 Six Outlet Filter Lid
10  04-920 Bolt, Nut, Washer - set of 4.	25  04-962 High Flow Regulator
11  04-922 Brass Drain Tap	26  04-964 1/4 Inch Coupler 3/8 Inch MNPT - to fit 04-965 Manifold.
12  04-923 Base/Wall Mount	27  04-965 6 Outlet Manifold
13 04-924 Auto Drain Unit	28 04-966 1 Inch NPT Hex Connector
14 04-925 Micro Mist Filter 1/2 Inch	29 04-967 1 Inch NPT to 3/4 Inch BSP Bushing
15 04-926 1 Inch x 1/2 Inch Reducing Nipple	







The GX4® Gas Monitor detects up to four gases simultaneously, alerting the user when there are hazardous gases present near the supplied air source. All data and logs can be accessed in real time.



GX4 Gas Monitor Packages

Part #	Description	Certifications
08-400-G	 GX4 Gas Monitor - No Sensor Package also includes: ■ Power adaptor pack ■ Mounting brackets ■ Air supply hose.	
08-401	 GX4 Gas Monitor - No Sensor with 12 volt Cable with Battery Clips Package also includes: ■ Mounting brackets ■ Air supply hose.	

GX4 Gas Monitor Sensors









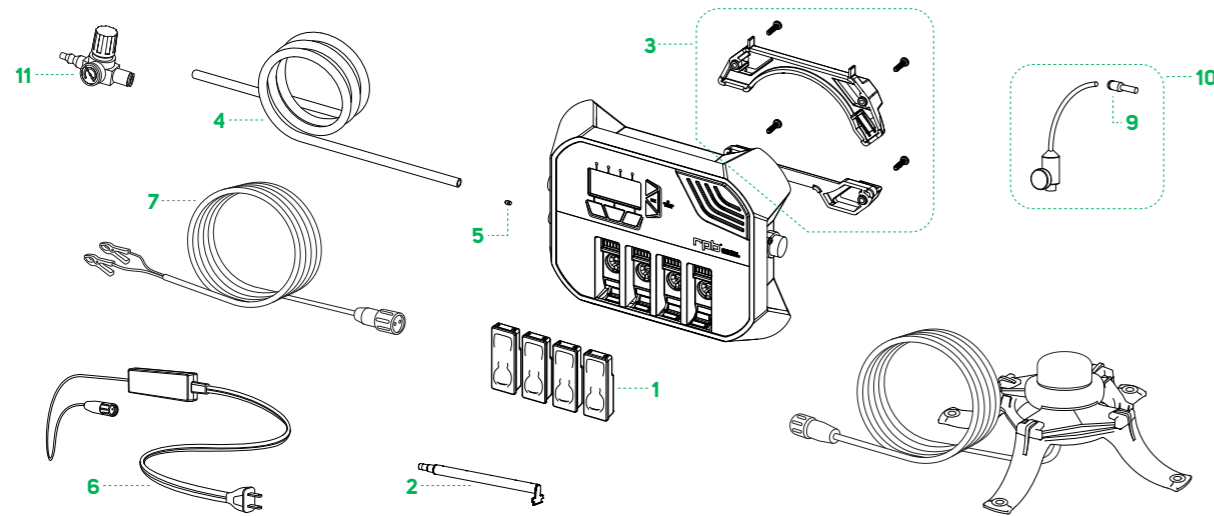





Part #	Description	Certifications
08-420-01	 Gas Sensor Cartridge - Carbon Monoxide - CO 10ppm	
08-420-02	 Gas Sensor Cartridge - Carbon Monoxide - CO 5ppm	
08-420-03	 Gas Sensor Cartridge - Hydrogen Sulphide - H2S 10ppm	
08-420-04	 Gas Sensor Cartridge - Oxygen - O2 19.5-23%	

GX4 Gas Monitor Accessories

Part #	Description	Certifications
08-231	 Wall Bracket	
08-424	 Heavy Duty Field Case	
08-434	 Auxiliary Cable 15m with Bare End	
08-435	 Strobe Light with 15m Cable	
08-436	 Auxiliary Strobe & Alarm Tower with 15m Cable	

GX4 Gas Monitor Parts



Part # / Description	Part # / Description
1  08-420 Blank Sensor Case	8  08-437 AUX, Field Install Jack
2  08-422 Sensor Manifold Tube	9  08-450 Calibration Adapter
3  08-425 Mounting Bracket <i>- pair, includes screws.</i>	10  08-451 Calibration Flow Regulator <i>- for CO & Zero Air Gas Bottles, includes 08-450.</i>
4  08-428 Air Supply Hose <i>- includes one touch connector.</i>	10  08-452 Calibration Flow Regulator <i>- for H2S Gas Bottles, includes hose and fitting.</i>
5  08-429 M5 Inlet Filter	11  08-470 External Flow Regulator
6  08-430-EU Power Pack Assembly - EU	-  09-021-EU RPB® Power Cable - EU plug
6  08-430-UK Power Pack Assembly - UK	-  09-021-UK RPB® Power Cable - UK plug.
7  08-431 12 Volt Battery Clip & Plug	



Two columns of horizontal dotted lines for writing notes.

Copyright ©2022 RPB® Safety, LLC. All rights reserved.

All materials contained in this publication are protected by United States copyright law and may not be reproduced, distributed, transmitted, displayed, published or broadcast without the prior written permission of RPB® Safety, LLC. You may not alter or remove any trademark, copyright or other notice from copies of the content.

Trademarks and Other Intellectual Property

All trademarks, service marks, and logos used in this publication, both registered and unregistered, are the trademarks, service marks, or logos of their respective owners. The green and gray color combination is a registered trademark of RPB® Safety, LLC. All rights in the GVS-RPB Intellectual Property contained in this publication, including copyright, trademarks, service marks, trade secret, and patent rights are reserved. GVS-RPB Intellectual Property means any patent, patented articles, patent applications, designs, industrial designs, copyrights, software, source code, database rights, moral rights, inventions, techniques, technical data, trade secrets, know-how, brands, trademarks, trade names, slogans, logos, and any other common law and proprietary rights, whether registered or unregistered anywhere in the world, that are owned by, developed in whole or in part by, or licensed by GVS S.p.A or RPB® Safety, LLC.

DuPont™ Tychem® is a registered trademark of E.I. du Pont de Nemours and Company or its affiliates.

⚠ WARNING PRODUCT SELECTION

- 1. Determine what type of protection is required for your activity.** As applicable, check your workplace safety program, respiratory protection program, and standards and regulations for your activity or industry.
 - 2. Check product specifications.** Contact GVS-RPB® or check the product instruction manual (downloadable from gvs-rpb.com) for complete specifications, including approvals, standards, and regulations to which the product conforms.
 - 3. Make sure you have a complete system.** Verify that you have or are purchasing all required components. System requirements are available from GVS-RPB® or in product instruction manuals.
- Selecting inappropriate or incomplete equipment, including the use of counterfeit or non-GVS-RPB® parts, can result in inadequate protection and will void the NIOSH approval of the entire respirator.**



SCOPRI IL NOSTRO PORTALE DEDICATO AL MONDO DELLE IMPRESE.

È ESCLUSIVO

Pensato per te che sei un cliente business. Ti diamo accesso diretto al nostro magazzino. Zero perdite di tempo. Zero imprevisti. Sconti e promozioni pensati per te. Controllo completo sull'ordine.

È POTENTE

Puoi ordinare da qualsiasi dispositivo online. A qualsiasi ora. Su tutto il catalogo prodotti. Preventivo di spesa in tempo reale. Salvataggio prodotti ricorrenti. Programmazione delle scorte.

È SEMPRE IN ORDINE

Preventivi. Ordini. DDT. Fatture. Tutto digitale, tutto online, sempre accessibile. Un gestionale al tuo servizio.

SIKURA SRL

Via Raffaello Sanzio, 3/A • 31021 Mogliano Veneto (TV)
T. 041.5442068 / F. 041 5442631 / info@sikura.it